

ELKO EP, s.r.o.
 Palackého 493
 769 01 Holešov, Vsetuly
 Czech Republic
 Tel.: +420 573 514 211
 e-mail: elko@elkoep.com
 www.elkoep.com

Made in Czech Republic
 24-7-2018 Rev.: 0



VS116B/230, VS116K, VS116U, VS308K, VS308U, VS316

Power relays



Characteristics

- Power relay used for switching larger load output, strengthen or „multiplying“ contacts of the existing device.
- Relays VS316/24, VS316/230 enable connection to a 3-phase circuit.
- In the design 1-MODULE , DIN rail mounting, output status indicated by high intensity LED with choice of LED color (red, green, yellow, blue or white LED*).
- VS116/B230 MINI, mounting in installation box or ceilings, enabling switching of lights, motors for blinds or awnings.
- For VS116/B230 status of output indicated by LED on front panel of device.

Symbol

VS116B/230

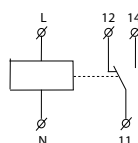

VS116K

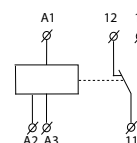

VS116U

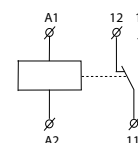

Notes

Max. time of changeover of contact is 10ms.

VS316/24 or VS316/230 enables switching of different phases or 3 phase voltage.

*Possibility to choose blue, white and yellow color of LED for power relays line VS in case of minimal order quantity 100 pcs.

VS308K

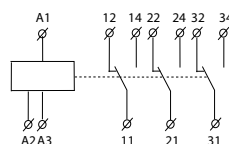

VS308U, VS316/24, VS316/230

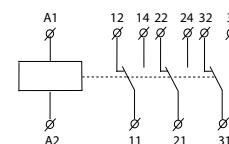

Description

VS116K, VS116U

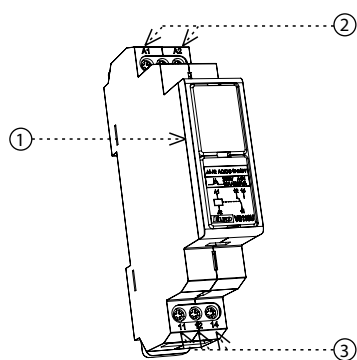

terminal A3 only for VS116K

VS308K, VS308U

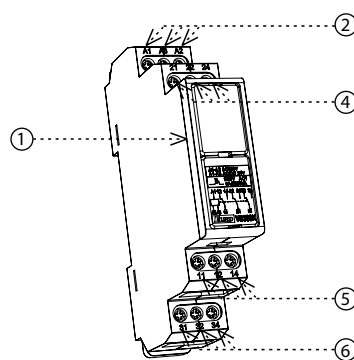

terminal A3 only for VS308K

VS316/24, VS316/230

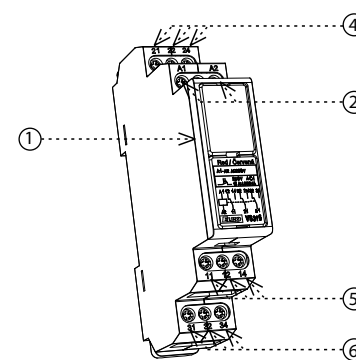

VS116B/230

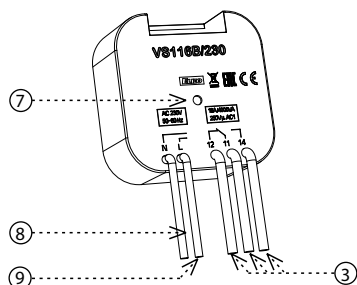

1. Indication LED
2. Supply terminals
3. Output changeover contact
4. 2nd output changeover contact
5. 1st output changeover contact
6. 3rd output changeover contact
7. Output indication
8. Neutral wire
9. Phase wire

Technical parameters

	VS116B/230	VS116K	VS116U	VS308K	VS308U	VS316/24	VS316/230
Supply terminals:	L - N		A1 - A2				
Voltage range:	AC 230 V / 50-60 Hz	AC 230 V / 50-60 Hz	AC/DC 12-240 V / 50-60 Hz	AC 230 V / 50-60 Hz	AC/DC 12-240 V / 50-60 Hz	AC/DC 24 V / 50-60 Hz	AC 230 V / 50-60 Hz
Burden:	AC max. 7.5 VA / 1 W	AC max. 7.5 VA / 1 W	AC 0.7 - 3 VA/ DC 0.5 - 1.7 W	AC max. 10.3 VA / 1.1 W	AC 0.7 - 3 VA/ DC 0.5 - 1.7 W	1.6 VA / 1.2 W	2.5 VA
Supply terminals:	x	A1 - A3	x	A1 - A3	x		
Voltage range:	x	AC/DC 24 V (50-60 Hz)	x	AC/DC 24 V (50-60 Hz)	x		
Burden:	x	AC 1 VA/ DC 1W	x	AC 1 VA/ DC 1W	x		
Supply voltage tolerance:	-15%; +10%						
Max. dissipated power (Un + terminals):	4 W			3 W		8 W	6 W

Output

Number of contacts:	1 x changeover/ SPDT (AgSnO ₂)		3 x changeover/TPDT (AgNi / Silver Alloy)		3 x changeover/ TPDT (AgSnO ₂)		
Current rating:	16 A/ AC1		8 A/ AC1		16A/ AC1		
Breaking capacity:	4000VA/ AC1, 384W/ DC		2000VA/ AC1, 192W/ DC		4000VA/ AC1, 384W/ DC		
Inrush current:	30 A/ <3s		10 A/ <3s		30 A/ <3s		
Switching voltage:	250 V AC1/ 24 V DC						
Output indication:	red LED	high intensity of LED					
Mechanical life:	3x10 ⁷					1x10 ⁷	
Electrical life (AC1):	0.7x10 ⁵					1x10 ⁵	
Time between switching:	min. 2s					20 ms	50 ms



















Other information

Operating temperature:	-20.. +55 °C						
Storage temperature:	-30.. +70 °C						
Electrical strength:	4 kV (supply-output)						
Operating position:	any						
Mounting:	free at connecting wire	DIN rail EN 60715					
Protection degree:	IP30	IP40 from front panel / IP20 terminals					
Overvoltage category:	III.						
Pollution degree:	2						
Max. cable size (mm ²):	2x 0.75 mm ² (AWG 18), 3x 2.5 mm ² (AWG 10)	max. 1x 2.5 or 2x 1.5 max. 1x 2.5 (AWG 12)					
Dimensions:	49 x 49 x 21 mm (2" x 2" x 0.8")						
Weight:	48 g (1.7 oz.)	56 g (2 oz.)	59 g (2.1 oz.)	78 g (2.75 oz.)	80 g (2.8 oz.)	90 g (3.17 oz.)	93 g (3.3 oz.)
Standards:	EN 61810-1, EN 61010-1						



















Warning

Device is constructed for connection for 1-phase main AC 24-240V, DC24V and must be installed according to norms valid in the state of application. Connection according to the details in this direction. Installation, connection, setting and servicing should be installed by qualified electrician staff only, who has learnt these instruction and functions of the device. This device contains protection against overvoltage peaks and disturbances in supply. For correct function of the protection of this device there must be suitable protections of higher degree (A,B,C) installed in front of them. According to standards elimination of disturbances must be ensured. Before installation the main switch must be in position "OFF" and the device should be de-energized. Don't install the device to sources of excessive electro-magnetic interference. By correct installation ensure ideal air circulation so in case of permanent operation and higher ambient temperature the maximal operating temperature of the device is not exceeded. For installation and setting use screw-driver cca 2 mm. The device is fully-electronic - installation should be carried out according to this fact. Non-problematic function depends also on the way of transportation, storing and handling. In case of any signs of destruction, deformation, non-function or missing part, don't install and claim at your seller it is possible to dismount the device after its lifetime, recycle, or store in protective dump.

VS116K, VS116U, VS316

Type of load	 cos φ ≥ 0.95 AC1	 AC2	 AC3	 AC5a uncompensated	 AC5a compensated	 AC5b	 AC6a	 AC7b	 AC12
Mat. contacts AgSnO ₂ , contact 16A	250V / 16A	250V / 5A	250V / 3A	230V / 3A (690VA)	230V / 3A (690VA) to max. input C=14uF	1000W	x	250V / 3A	x
Type of load	 AC13	 AC14	 AC15	 DC1	 DC3	 DC5	 DC12	 DC13	 DC14
Mat. contacts AgSnO ₂ , contact 16A	x	250V / 6A	250V / 6A	24V / 10A	24V / 3A	24V / 2A	24V / 6A	24V / 2A	x

VS308K, VS308U

Type of load	 cos φ ≥ 0.95 AC1	 AC2	 AC3	 AC5a uncompensated	 AC5a compensated	 AC5b	 AC6a	 AC7b	 AC12
Mat. contacts AgNi, contact 8A	250V / 8A	250V / 3A	250V / 2A	230V / 1.5A (345VA)	x	300W	x	250V / 1A	250V / 1A
Type of load	 AC13	 AC14	 AC15	 DC1	 DC3	 DC5	 DC12	 DC13	 DC14
Mat. contacts AgNi, contact 8A	x	250V / 3A	250V / 3A	24V / 8A	24V / 3A	24V / 2A	24V / 8A	24V / 2A	x